

⚠ WARNING!

Be sure to read and fully understand this document before installing, operating, maintaining or servicing this appliance. Failure to do so can result in appliance failure, property damage, serious injury or death. Appliance failure, injury or property damage due to improper installation is not covered by warranty.

🔑 USER ACTION!

TRUE tracks the history of your appliance by its serial number. For easy reference, record your appliances full model name and serial number below. This information is on your serial label. Serial label location varies by appliance.

Model Name:

Serial Number:

TRUE MANUFACTURING CO., INC.
 2001 East Terra Lane • O'Fallon, Missouri 63366-4434
 (636) 240-2400 • FAX (636)-272-2408
 International FAX (636)272-7546 • (800)-325-6152
 Parts Department (800)-424- TRUE
 Parts Department FAX (636)-272-9471

INSTALLATION MANUAL
RETAIL MERCHANDISER
 Original Instructions

North America – Canada and Caribbean
 Warranty Phone: +1 855 878 9277
 Warranty Fax: +1 636 980 8510
 Technical Phone: +1 855 372 1368
 Warranty Email:
 warrantyinquiries@truemfg.com
 Technical Email:
 service@truemfg.com
 7:00 – 6:00 CST Monday – Friday.
 8:00 – 12:00 Saturday.

Mexico
 Phone: +52 555 804 6343/44
 service-mexicocity@truemfg.com
 9:00 am – 5:30 pm M–F

Latin America
 Phone: +52 555 804 6343/44
 servicelatam@truemfg.com
 9:00 am – 5:30 pm M–F

UK, Ireland, Middle East, Africa and India
 Phone: +44 (0) 800 783 2049
 service-emea@truemfg.com
 8:30 am – 5:00 pm M–F

European Union and Commonwealth of Independent States
 Phone: +41 61 563 0705
 service-emea@truemfg.com
 8:00 am – 5:00 pm M–F

Australia
 Phone: +61 2 9618 9999
 service-aus@truemfg.com
 8:30 am – 5:00 pm M–F



THANK YOU

FOR YOUR PURCHASE

Congratulations!

The primary purpose of this document is to assist the installation, maintenance, and servicing of your TRUE appliance. This document contains information important to safety, operation, maintenance, and servicing. **DO NOT** discard this document. TRUE is solely the appliance manufacturer. For assistance finding a qualified technician, please visit our Service Company Locator at truemfg.com/support/service-locator.

NOTICE!



Your appliance may not exactly match the figures shown in this manual.

Contents

Preface		Electronic Temperature Control Operation	
Signal & Symbol Definitions.....	3	Display Code Definitions.....	19
Important Safety Information		Lock/Unlock the Control.....	20
Signal & Symbol Definitions.....	3	Turn Off/On the Control.....	20
Basic Safety & Operation Warnings	4	View & Change the Set Point.....	21
Personal Injury Warnings.....	5	Initiate Manual Defrost	21
Hydrocarbon Refrigerant Warnings.....	6	Change Display Readout.....	22
Appliance Disposal Warnings	6	Change Displayed Probe Temperature	23
Electrical Safety Warnings.....	7	Maintenance & Servicing	
About Your Appliance & Installation Requirements		Component Replacement.....	25
Appliance Specifications	7	Recommended Maintenance	26
Clearances.....	7	Condenser Coil Cleaning.....	28
Electrical Requirements	8	General Surface Care & Cleaning	30
Installation & Setup		Stainless Steel Care & Cleaning.....	31
Shelf Adjustment.....	15	8 Tips to Help Prevent Rust on Stainless Steel.....	32
Appliance Operation		Door Adjustments & Reversal.....	33
Startup.....	16	Optional Accessories	
Temperature Control & Light Switch Location.....	17	Heated Drain Pan (HDP).....	39
General Sequence of Operation	18	Warranty	
		Warranty	42

Preface

The warning, guidelines, and recommendations within this document are meant to prevent appliance damage, injury, or death. Please carefully read all warnings, guidelines, and recommendations before proceeding to ensure the continued safe use and maintenance of your TRUE appliance.

Signal & Symbol Definitions

Below are symbols you may see in this document. Some symbols may not appear.

Signal Word Definitions	
DANGER!	An imminently hazardous situation which, if not avoided, will result in serious injury or death.
WARNING!	A potentially hazardous situation which, if not avoided, can result in serious injury or death.
CAUTION!	A potentially hazardous situation which, if not avoided, may result in minor or moderate injury; an unsafe practice.
USER ACTION!	User action alert, follow all recommendations to avoid appliance or product damage.
NOTICE!	Important information not related to hazards or risk of personal injury.

Safety Symbols	
	Safety alert; alerts reader to potential physical injury hazards. Obey all safety messages following this symbol to avoid possible injury or death.
	Flammable material; fire hazard.
	Electrical shock hazard.
	Tipping hazard; tip-over hazard.
	Sharp element; cut or sever hazard.
	Eye hazard; risk of eye injury.
	Exploding pressurized cylinder hazard.
	Slippery surface hazard.
	Crush or cut hazard.

Additional Symbols	
	Mandatory action alert symbol; alerts reader to required or recommended actions. Obey all messages and recommendations following this symbol to avoid appliance or product damage.
	Important information not related to hazards or risk of personal injury.
	Review and understand the installation manual before installing, operating, or servicing.
	Wear eye protection .
	Wear protective gloves .
	Secure gas cylinders to prevent falling cylinders.
	DO NOT use extension cord.
	DO NOT use adaptor plugs.
	DO NOT dispose of with other household waste.

Important Safety Information

Important Safety Information

Basic Safety & Operation Warnings

Follow basic safety precautions, including the following, to reduce risk of personal injury, electric shock, fire, or death.

⚠️ WARNING!



Be sure to read and fully understand this document before installing, operating, maintaining, or servicing this appliance. Failure to do so can result in appliance failure, property damage, serious injury, or death. Appliance failure, personal injury, or property damage due to improper installation is not covered by warranty.

- Failure to install, operate, and maintain the appliance as detailed in this document will negatively affect safety, appliance performance, component life, and warranty coverage.
- The appliance must be installed in accordance with all applicable laws, codes, and regulations.
- The manufacturer cannot be held responsible for injury or damage resulting from improper, incorrect, and unreasonable use.
- This appliance is not to be used, cleaned, or maintained by persons (including children) with reduced physical, sensory, or mental capabilities or lack of experience and knowledge, without proper supervision or instruction.
- **DO NOT** install or operate equipment that has been misused, abused, neglected, damaged, or altered/modified from original manufactured specifications.
- **DO NOT** modify or alter the appliance. Improper alterations can result in electric shock, personal injury, fire, or death.
- **DO NOT** use electrical appliances inside the food storage compartments of the units unless the appliances are approved by the manufacturer.
- The appliance owner is responsible for performing a Personal Protective Equipment (PPE) Hazard Assessment and to ensure adequate protection during maintenance and cleaning procedures.
- Use appropriate tools, safety equipment, and PPE during installation and servicing.
- Only use the appliance for its intended purpose as described in this document. Failure to do so may result in equipment damage, personal injury, or death.
- Overloading, incorrectly installing, or improperly loading shelves can cause shelf failure (as well as negatively affect the appliance's operation), resulting in appliance damage, product damage, or personal injury.
- Keep the area surrounding the appliance clean to avoid appliance damage from debris or pests.

Important Safety Information (cont.)

Personal Injury Warnings

Only qualified technicians should install and service the appliance. For assistance finding a qualified technician, please visit our Service Company Locator at truemfg.com/support/service-locator. TRUE is solely the appliance manufacturer and is not responsible for installation.

⚠ DANGER!

	<p>DO NOT allow children to play with or in the appliance. Child entrapment or personal injury can occur.</p>
	<p>DO NOT store or use the following in the vicinity of this or any other appliance:</p> <ul style="list-style-type: none"> • Gasoline or other flammable vapors and liquids • Combustible or explosive substances, such as aerosol cans with a flammable propellant • Other volatile or flammable substances
 	<p>Contact TRUE Manufacturing to locate refrigerant lines and electrical wiring before drilling, cutting or puncturing interior or exterior walls. Failure to do so could result in damage, personal injury, or death.</p>

⚠ WARNING!

	<p>Only qualified technicians should install and service the appliance.</p> <ul style="list-style-type: none"> • Use appropriate tools, safety equipment, and personal protective equipment (PPE) during installation and servicing. • DO NOT touch the cold surfaces in the freezer compartment when hands are damp or wet. Skin may stick to extremely cold surfaces.
	<p>This product can expose you to chemicals including Di-(2-Ethyl hexyl) Phthalate (DEHP), which is known to the State of California to cause cancer and birth defects or other reproductive harm. For more information go to P65warnings.ca.gov.</p>
	<p>Slippery Surfaces! Moisture from improper drainage can create slippery surfaces near the appliance. It is your duty to immediately warn your customers of, and dry, the slippery surface. All wet floor areas must be marked with a wet floor sign.</p>
	<p>Sharp edges! Take care when moving, installing, cleaning, servicing, and maintaining the appliance to avoid cuts. Be sure to take care when reaching under the appliance or handling metal components.</p> <ul style="list-style-type: none"> • Keep fingers out of pinch point areas, such as the space between appliance doors and surrounding cabinetry. Take care closing doors with children nearby.
	<p>Tip over hazard! Appliance may pose a tipping hazard when uncrating, installing, or moving the appliance. Take appropriate safety precautions. Use of tip over restraints may only reduce (not eliminate) the tipping hazard. Never allow children to climb or hang on drawers, doors, or shelves.</p>
	<p>Crush or cut hazard! Keep clear when uncrating, installing, moving, or servicing the appliance.</p>
	<p>Risk of electric shock or burn! See "Electrical Safety Warnings" for more information.</p>



Important Safety Information (cont.)

Hydrocarbon Refrigerant Warnings

TRUE appliances use hydrocarbon refrigerant (R-290/513A/600a). Check the serial label to identify the appliance's refrigerant. Serial label location varies by model.

⚠ DANGER!	
	<p>Risk of fire or explosion! Flammable refrigerant used.</p> <ul style="list-style-type: none"> All servicing and maintenance must be performed by qualified technicians. This is to minimize the risk of fire or personal injury due to incorrect parts or improper service. Check the serial label to identify the appliance's refrigerant. Serial label location varies by model. DO NOT damage the refrigeration system during transportation and installation. If the appliance is damaged, verify the refrigeration system's integrity is not compromised before proceeding. Never use sharp objects or tools to remove ice or frost. DO NOT use mechanical devices to accelerate defrost. Dispose of in accordance with all applicable laws, codes, and regulations. Follow all safety precautions associated with handling flammable refrigerant. DO NOT use electrical appliances inside the food storage compartments of the units unless the appliances are of the type recommended by the manufacturer.

Appliance Disposal Warnings

⚠ DANGER!	
	<p>Risk of child entrapment!</p> <p>Children can get trapped inside discarded appliances and suffocate. Never dispose of your appliance without taking precautions to prevent child entrapment, even if the appliance only sits unattended for a short period of time.</p> <p>Child entrapment precautions include the following:</p> <ul style="list-style-type: none"> Remove all doors (or drawers for drawer units). Leave all interior drawers and shelving in place to make climbing (and fitting) inside the appliance more difficult.
	<p>Risk of fire or explosion! Flammable refrigerant and insulation used. Dispose of in accordance with all applicable laws, codes, and regulations. Follow all safety precautions associated with handling flammable refrigerant and insulation.</p>
	<p>DO NOT dispose of your appliance with household waste.</p>



About Your Appliance & Installation Requirements

About Your Appliance & Installation Requirements

! USER ACTION!

!

TRUE is not responsible for damage incurred during shipment. Always carefully inspect for freight damage before receiving and installing your appliance. If there is damage, note all damage on the delivery receipt, immediately file a claim with the delivery freight carrier, and contact TRUE. **Do not install the appliance or put it in service.**

Thank you for choosing TRUE Manufacturing to meet your refrigeration needs. TRUE highly recommends a qualified technician and electrician install your appliance to ensure correct installation. The cost of professional installation is money well spent. Only qualified technicians should install and service the appliance.

For assistance finding a qualified technician, please visit our Service Company Locator at truemfg.com/support/service-locator. TRUE is solely the appliance manufacturer and is not responsible for installation.

The appliance owner is responsible for proper installation and maintaining the appliance as described in this document. Routine care and maintenance procedures are not covered by TRUE's warranty.

Appliance Specifications

Some things to know about your appliance are as follows:

- Appliance is not for the storage and/or display of potentially hazardous foods when the temperature control is set above 41 °F (5 °C).
- Appliance is not suitable for outdoor use, unless otherwise stated on the serial label.
- Appliance is not suitable for an area where a pressure washer or hose may be used.
- Always plug the appliance into its own individual dedicated electrical circuit!
- **DO NOT** use extension cords or adapter plugs.
- Before connecting your appliance to the power supply, verify the incoming voltage (±5%) and the amps match the operation ratings on the appliance's serial label. Correct improper incoming voltage or amps immediately. Serial label location varies by model.
- Before connecting your appliance to the power supply, verify the power supply is correctly grounded. If the power supply is not grounded, correct immediately.
- Ensure the installation location will provide adequate clearances and sufficient airflow for the cabinet. See "Clearances".
- Read and follow all warnings and maintenance instructions. Failure to do so may result in damage and void the warranty on your appliance.

Clearances

Be sure your unit has the required surrounding clearances for ventilation purposes. Keep all ventilation openings in the appliance enclosure or structure housing the appliance clear of obstruction.

Model	Side(s)	Top	Back
TRM Freezer	0" (0 mm)	6" (152.4 mm)	0" (0 mm)
TRM Refrigerator	0" (0 mm)	6" (152.4 mm)	0" (0 mm)

About Your Appliance & Installation Requirements (cont.)

Electrical Requirements

! USER ACTION!

Find a copy of the wiring diagram with our serial number lookup at truemfg.com/support/serial-number-lookup

Each TRM requires one (1) individual dedicated circuit

See available locations for wall outlets by model in the following diagrams.

Electrical Requirements

Electrical Specifications					
Model	Power Cord	Voltage	Frequency	Phase	Circuit Size
TRM2L	L6-20P	208/240 V	60 Hz	1	20 amp
TRM2M	L6-20P	208/240 V	60 Hz	1	20 amp
TRM3L	L6-20P	208/240 V	60 Hz	1	20 amp
TRM3M	L6-20P	208/240 V	60 Hz	1	20 amp
TRM4L	L6-30P	208/240 V	60 Hz	1	30 amp
TRM4M	L6-20P	208/240 V	60 Hz	1	20 amp

Wire gauge chart (115V)

115 Volts												
Distance in Feet to Center of Load												
AMPS	20	30	40	50	60	70	80	90	100	120	140	160
2	14	14	14	14	14	14	14	14	14	14	14	14
3	14	14	14	14	14	14	14	14	14	14	14	12
4	14	14	14	14	14	14	14	14	14	14	12	12
5	14	14	14	14	14	14	14	12	12	12	10	10
6	14	14	14	14	14	14	12	12	12	10	10	10
7	14	14	14	14	14	12	12	12	10	10	10	8
8	14	14	14	14	12	12	12	10	10	10	8	8
9	14	14	14	12	12	12	10	10	10	8	8	8
10	14	14	14	12	12	10	10	10	10	8	8	8
12	14	14	12	12	10	10	10	8	8	8	8	6
14	12	12	12	10	10	10	8	8	8	6	6	6
16	12	12	12	10	10	8	8	8	8	6	6	6
18	12	12	10	10	8	8	8	8	8	8	8	5
20	12	12	10	10	8	8	8	6	6	6	5	5
25	10	10	10	8	8	6	6	6	6	5	4	4
30	10	10	8	8	6	6	6	6	5	4	4	3

Wire gauge chart (230V)

230 Volts												
Distance in Feet to Center of Load												
AMPS	20	30	40	50	60	70	80	90	100	120	140	160
5	14	14	14	14	14	14	14	14	14	14	14	14
6	14	14	14	14	14	14	14	14	14	14	14	12
7	14	14	14	14	14	14	14	14	14	14	12	12
8	14	14	14	14	14	14	14	14	14	12	12	12
9	14	14	14	14	14	14	14	14	12	12	12	10
10	14	14	14	14	14	14	14	12	12	12	10	10
12	14	14	14	14	14	14	12	12	12	10	10	10
14	12	12	12	12	12	12	12	12	10	10	10	8
16	12	12	12	12	12	12	10	10	10	10	8	8
18	12	12	12	12	12	10	10	10	10	8	8	8
20	12	12	12	12	10	10	10	10	10	8	8	8
25	10	10	10	10	10	10	10	10	8	8	6	6
30	10	10	10	10	10	10	8	8	8	6	6	6

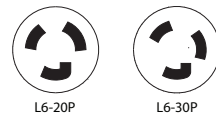



Fig. 1. NEMA plug configurations.

About your Appliance & Installation Requirements

Electrical Requirements

 = Potential Wall Outlet Location

TRM2L Outlet Location

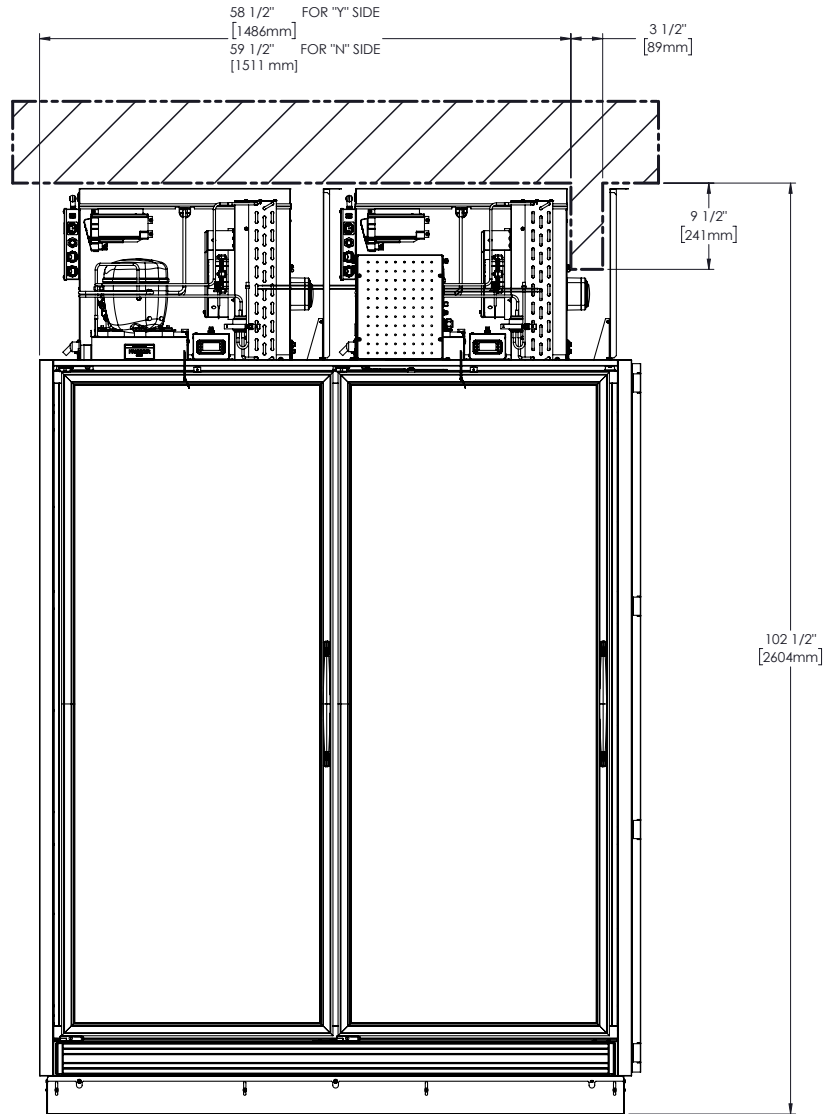

About your Appliance & Installation Requirements (cont.)

 = Potential Wall Outlet Location

TRM2M Outlet Location

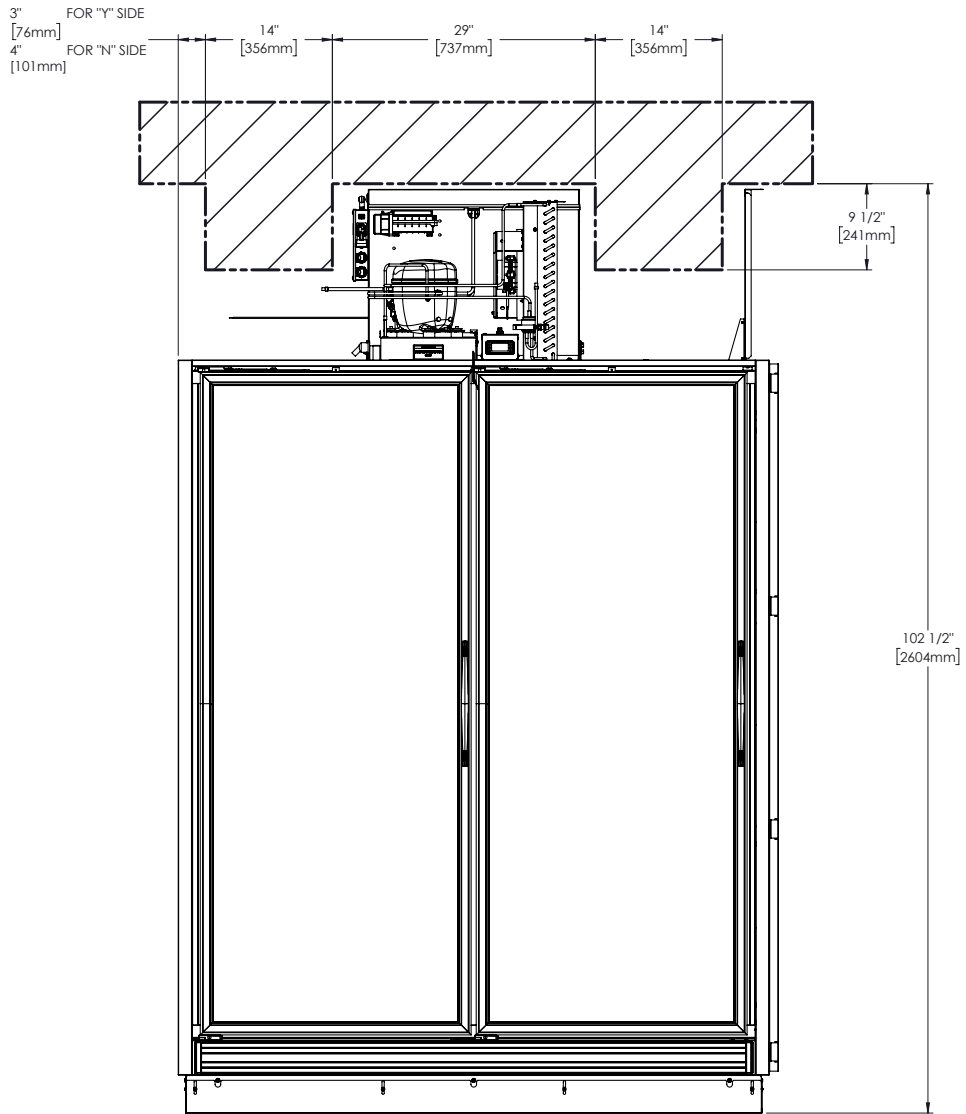

About Your Appliance & Installation Requirements (cont.)

 = Potential Wall
Outlet Location

TRM3L/TRM3M Outlet Location

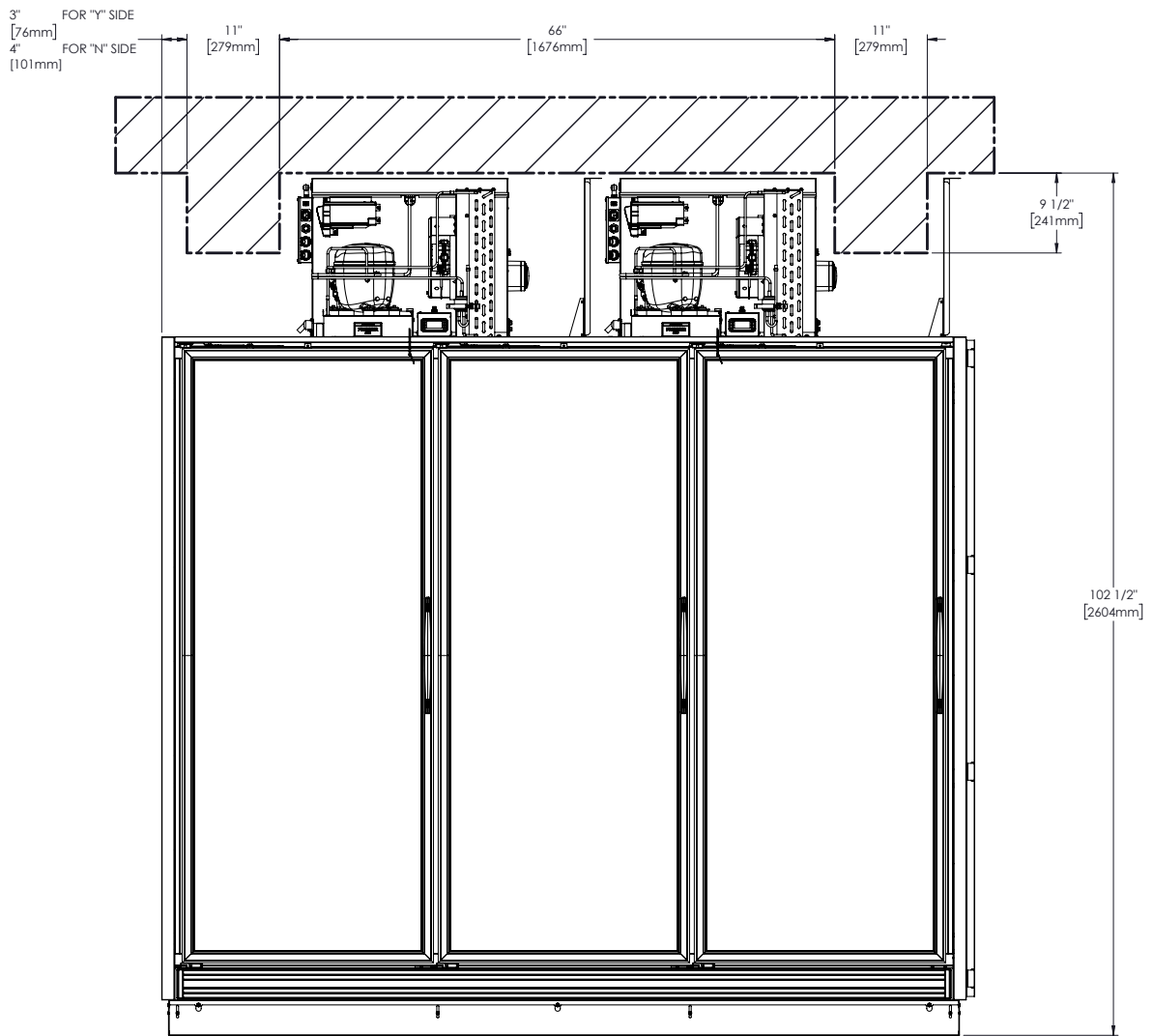

About your Appliance & Installation Requirements (cont.)

 = Potential Wall
Outlet Location

TRM4L Outlet Location

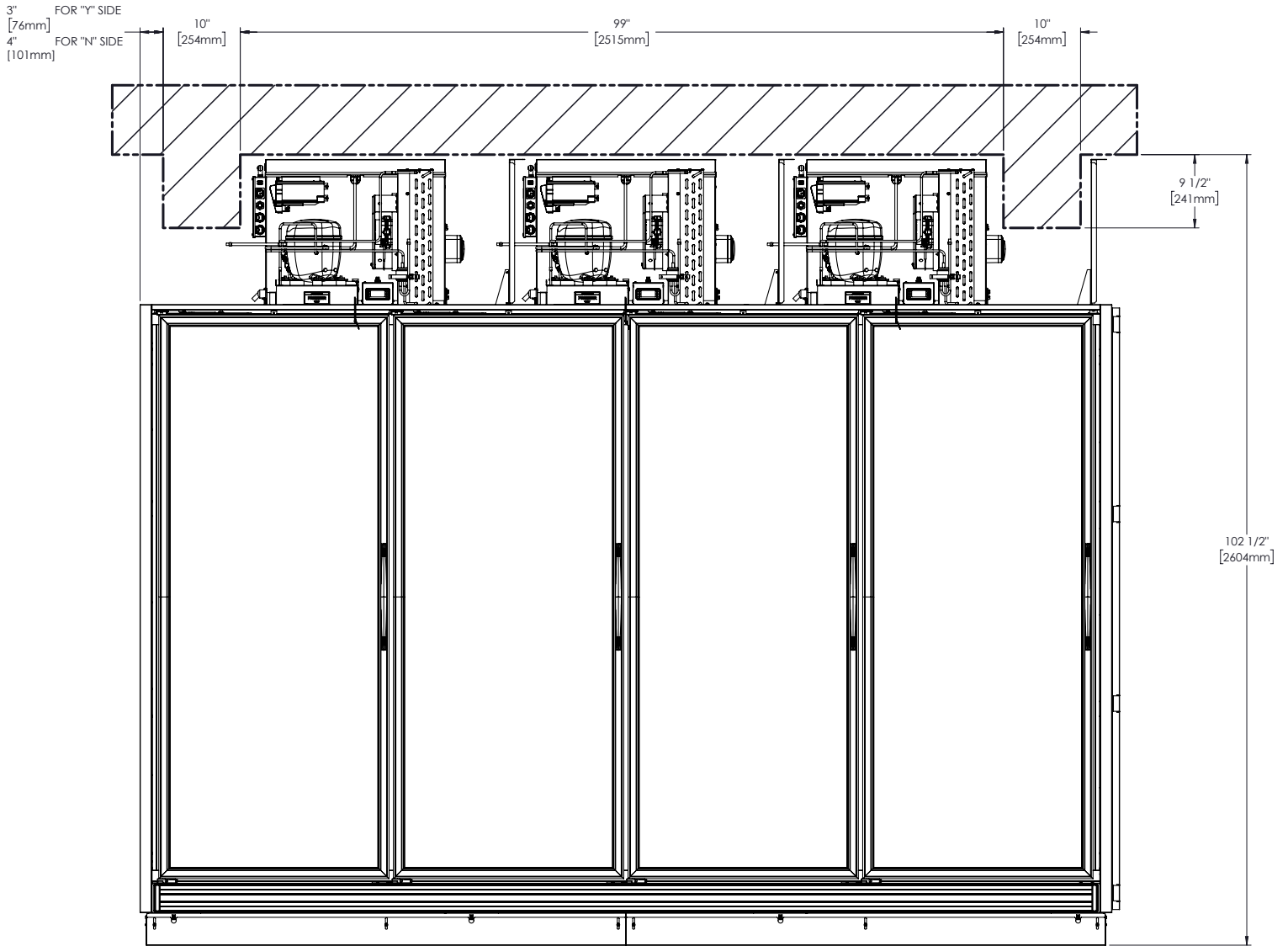

About your Appliance & Installation Requirements (cont.)



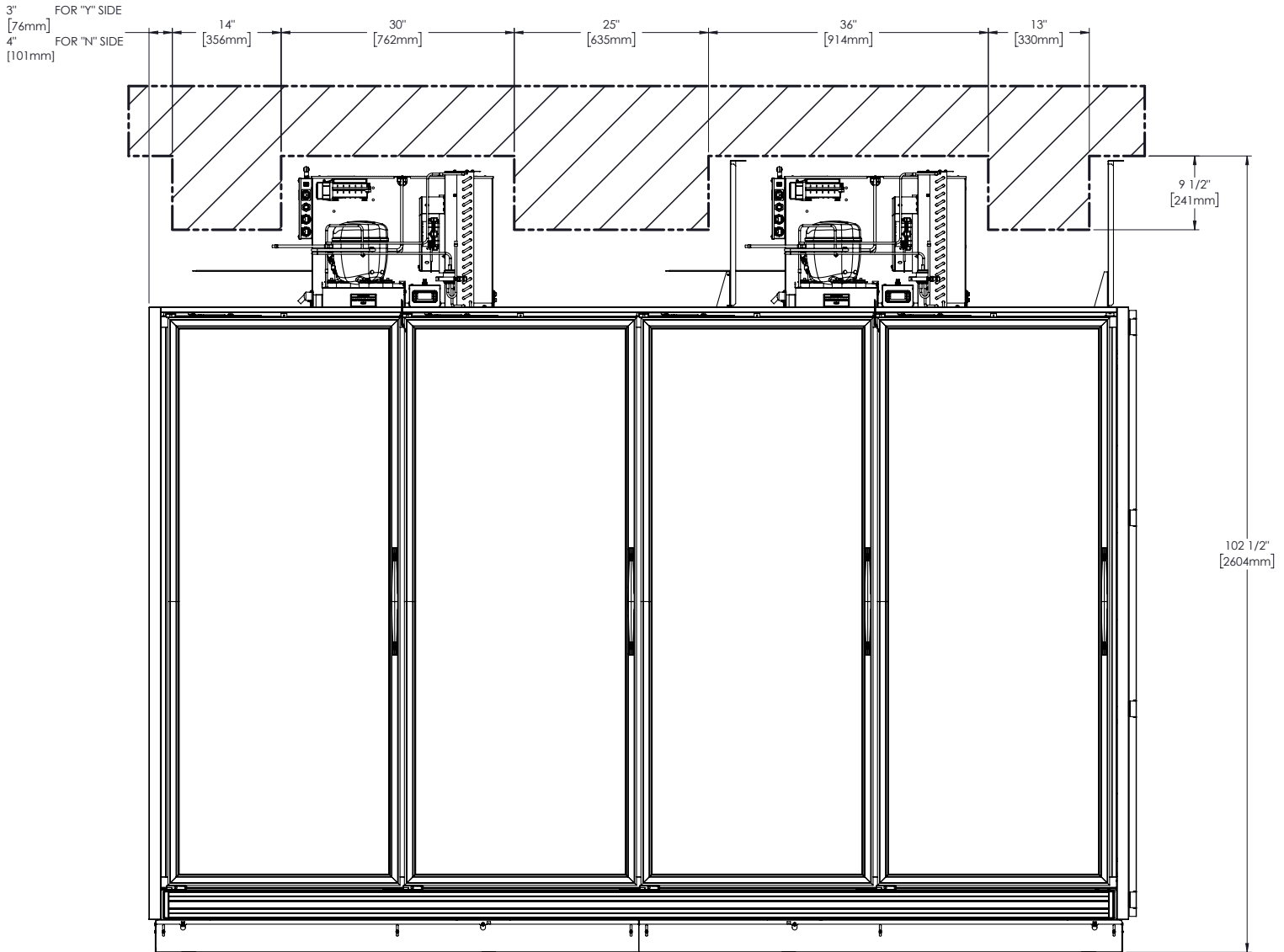

 = Potential Wall
Outlet Location



TRM4M Outlet Location



Installation & Setup

Installation & Setup

⚠ WARNING!	
  	<p>The appliance owner is responsible for performing a Personal Protective Equipment (PPE) hazard Assessment and to ensure adequate protection during maintenance and cleaning procedures.</p> <p>Use appropriate tools, safety equipment, and PPE during installation and servicing.</p>
	<p>Sharp edges! Take care when moving, installing, cleaning, servicing and maintaining the appliance to avoid cuts. Be sure to take care when reaching under the appliance or handling metal components. Keep fingers out of pinch point areas, such as the space between appliance doors and surrounding appliances. Take care closing doors with children nearby.</p>

⚠ WARNING!	
	<p>Risk of electrical shock or burn! Powering off an electronic control or setting temperature controls to the 0 (off) position does not remove power from all components. Unplug the appliance or turn off the power supply before installation or servicing.</p>
	<p>Tip over hazard! Appliance may pose a tipping hazard when uncrating, installing or moving the appliance. Take appropriate safety precautions. Use of tip over restraints may only reduce (not eliminate) the tipping hazard. Never allow children to climb or hang on drawers, doors or shelves.</p>
	<p>Crush or cut hazard! Keep clear when uncrating, installing, moving, or servicing the appliance.</p>

Installation & Setup (cont.)

Shelf Adjustment

ⓘ USER ACTION!

! DO NOT adjust shelving until AFTER the installation process is complete. Foam cylinders and caps MUST be installed in the leveling leg holes. See fig 1. Please see installation packet for more details

1. Remove the shelf shipping bracket, shelf cable ties, and shipping tape. See figs. 2 and 3.
2. Lift the shelf assembly and then pull the shelf assembly forward. See fig. 4.
3. Hook the shelf assembly into the shelf standards at the desired height.
4. Repeat steps 1-3 for the remaining shelves.

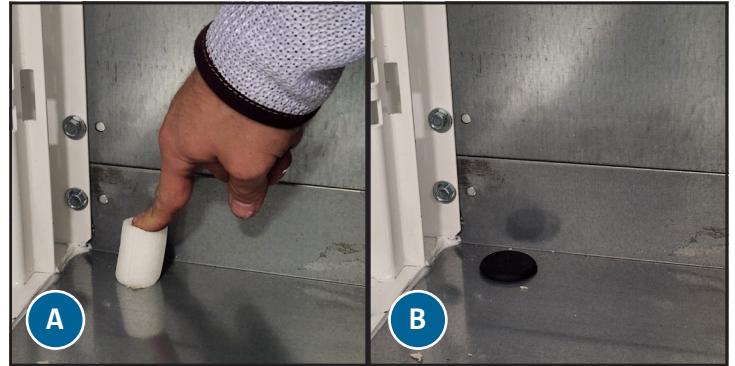

Fig. 1. Plugging (A) and capping (B) a leveling leg hole.

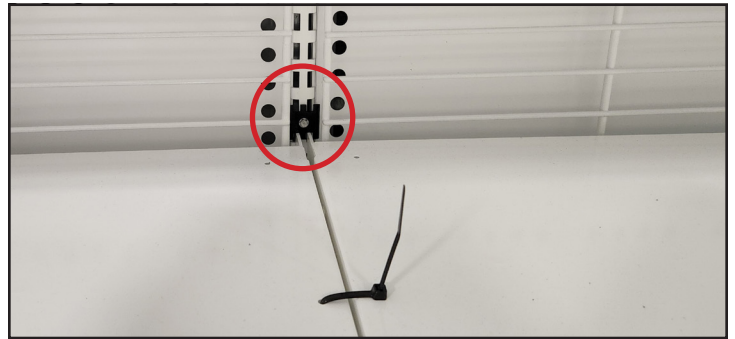

Fig. 2. Shelf shipping bracket location. One bracket shown.



Fig. 3. Shelf cable ties and shipping tape. Not all cable ties or tape shown.

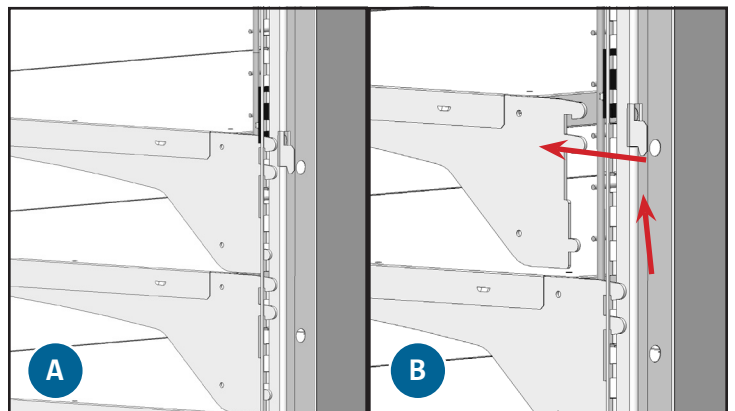

Fig. 4. Lift the shelf and pull forward.

Appliance Operation

Appliance Operation

⚠ WARNING – SPOILAGE!



The owner is solely responsible for ensuring safe holding temperature levels for all food items. Failure to do so may result in unsafe food products. Loss or spoilage of products in your appliance is not covered by warranty. In addition to following recommended installation procedures, run the appliance for 24 hours prior to usage to verify operation.



Startup

ⓘ USER ACTION!



Before loading product, run your TRUE appliance empty for 24 hours to verify proper operation. Remember, our factory warranty **DOES NOT** cover product loss!

- The compressor is ready to operate when the appliance is purchased. All you need to do is plug in the appliance.
- Good air flow inside your TRUE appliance is critical. Take care to prevent product from pressing against the sides or back wall and coming within 4" (101.6 mm) of the evaporator housing. Refrigerated air off the evaporator coil must circulate throughout the appliance for even product temperatures.
- Excessive tampering with the control could lead to service difficulties. If replacing the temperature control is ever needed, be sure to order the replacement from your TRUE dealer or recommended service agent.
- All covers and access panels must be in place and properly secured before operating this appliance.

Appliance Operation (cont.)

Temperature Control & Light Switch Location

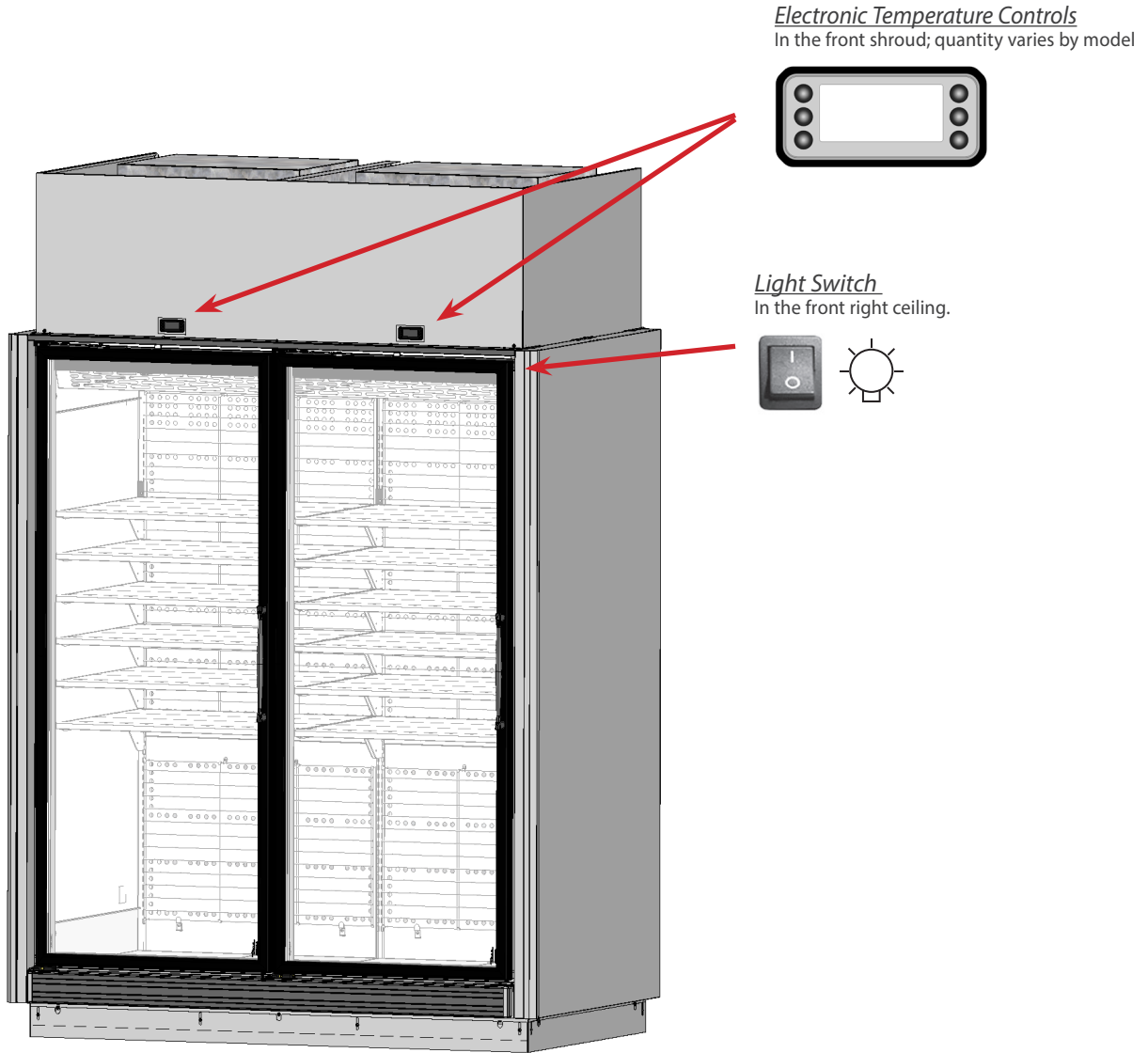

Appliance Operation (cont.)

General Sequence of Operation — Refrigerator and Freezer Appliances

ⓘ USER ACTION!



For more information regarding a appliance's temperature control adjustment or general sequence of operation, please see our Temperature Control Adjustment—Sequence of Operation Manual in our resource library at truemfg.com/service-manuals/sequence-of-operation or scan the **QR code**.

When the appliance is plugged in:

- Interior lights will illuminate on glass door models (see Temperature Control & Light Switch location, pg. 17).
- An electronic control with digital display will illuminate (if installed).
- There may be a short delay before the compressor and/or evaporator fan(s) start. This delay may be determined by time or by temperature, which could be the result of an initial defrost event that will last at least 6 minutes.
- The temperature control/thermostat may cycle the compressor and evaporator fan(s) on and off together. Every appliance will require a defrost event to ensure the evaporator coil remains clear of frost and ice buildup. Defrost is initiated by a defrost timer or by the electronic control.

EXCEPTION – Models TSID, TDBD, TCGG, and TMW do not have an evaporator fan(s).

- The temperature control/thermostat senses either an evaporator coil temperature or air temperature, NOT product temperature.
- An analog thermometer, digital thermometer, or electronic control display may reflect the refrigeration cycle swings of up and down temperatures, NOT product temperature. **The most accurate method to determine a appliance's operation is to verify the product temperature.**
- Refrigerators with mechanical temperature controls will defrost during every compressor off-cycle.
- Freezers with mechanical temperature controls will defrost by time initiation as determined by a defrost timer.

EXCEPTION – Models TFM, TDC, THDC and TMW require a manual defrost. The frequency of this manual defrost will depend on the appliance's usage and ambient conditions.

- An electronic control with a digital display (if installed) will show **DEF** during defrost.

NOTICE > The display may have a short delay before showing a temperature after a defrost event has expired and instead show **DEF** during a refrigeration cycle.

- Models with an analog or digital thermometer may show higher than normal temperatures during defrost.
- A refrigerator will use the evaporator fans to clear the coil during defrost.

EXCEPTION – Models TSID, TDBD, and TCGG do not have an evaporator fan(s).

- A freezer will use heaters to clear the evaporator coil during defrost.

NOTICE > The evaporator coil heater and drain tube heater are only energized during defrost. Defrost is terminated when a specific evaporator coil temperature is reached or by a time duration.

Electronic Temperature Control Operation

DIXELL XR70CH CONTROL LEGEND



- Display readout
- Up arrow
- Compressor Running
- Manual defrost
- Down arrow
- Evaporator Fan Running
- Set point
- Power/Stand-by
- Fans enabled
- Alarm occurring

Display Code Definitions

dA	Door switch alarm
dEF	Defrost in progress
EE	Data or memory failure
HA	Maximum temperature alarm
LA	Minimum temperature alarm
oFF	Controller in stand-by
P1	Thermostat probe failure
P2	Evaporator probe failure
P3	Auxiliary probe failure
PoF	Control is locked
Pon	Control is unlocked

Electronic Temperature Control Operation (cont.)

DIXELL XR70CH CONTROL LEGEND



- Display readout
- Up arrow
- Compressor Running
- Manual defrost
- Down arrow
- Evaporator Fan Running
- Set point
- Power/Stand-by
- Fans enabled
- Alarm occurring

Lock/Unlock the Control

Press and hold both the up and down arrows until the display shows **PoF** (locked) or **Pon** (unlocked).

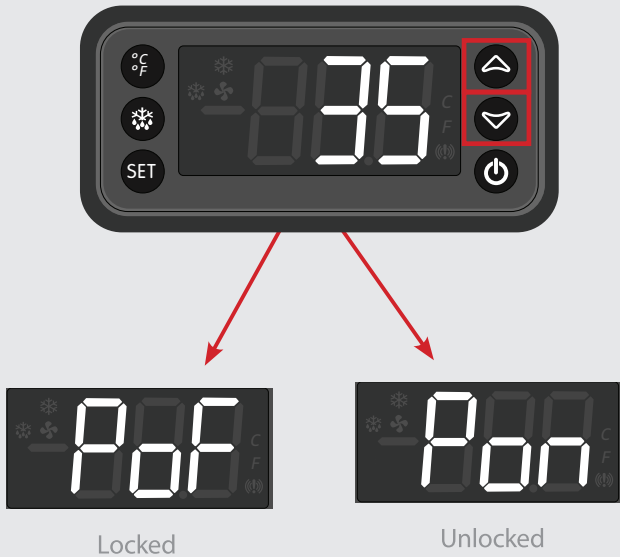

Turn Off/On the Control

⚠ WARNING!

Risk of electric shock or burn!
Powering off an electronic control or setting temperature controls to the 0 (off) position does not remove power from all components. Unplug the appliance or turn off the power supply before installation or servicing.

Turning off the control deactivates all electronic components connected to the control.

Push and hold the power button until the display shows **OFF** (stand-by) or the current appliance temperature (powered).



Electronic Temperature Control Operation (cont.)

DIXELL XR70CH CONTROL LEGEND



- Display readout
- Manual defrost
- Set point

- Up arrow
- Down arrow
- Power/Stand-by

- Compressor Running
- Evaporator Fan Running
- Fans enabled
- Alarm occurring

View the Set Point

Changing the set point adjusts the appliance temperature to keep optimal product temperature.

Press the set point button. The display shows the current set point.



Change the Set Point

1. With the control unlocked, press and hold the set point button for at least two (2) seconds. The display shows the current set point with **C** or **F** flashing.



2. With the up or down arrow buttons, adjust the set point.



Initiate Manual Defrost

A manual defrost clears accumulated frost and ice from the evaporator coil. The defrost will only terminate when a specific preset temperature or duration has been met.

With the control unlocked, press and hold the defrost button until the display shows **dEF**.



Electronic Temperature Control Operation (cont.)

DIXELL XR70CH CONTROL LEGEND



Display readout



Up arrow



Compressor Running



Manual defrost



Down arrow



Evaporator Fan Running



Set point



Power/Stand-by



Fans enabled



Alarm occurring

Change Display Readout

The display can show the temperature in either Fahrenheit or Celsius.

Press and hold the display readout  button to change the system of measure.



Electronic Temperature Control Operation (cont.)

DIXELL XR70CH CONTROL LEGEND



- Display readout
- Up arrow
- Compressor Running
- Manual defrost
- Down arrow
- Evaporator Fan Running
- Set point
- Power/Stand-by
- Fans enabled
- Alarm occurring

Change Displayed Probe Temperature

Follow the instructions to change what probe temperature the display shows.

- P1: Air temperature
- P2: Coil temperature

1. With the display unlocked, press and hold both the set point button and the down arrow until the display shows **HY**. Release the buttons.



2. Press the down arrow until the display shows **Lod**.



3. Press the set point button. The display will show the current probe displayed







4. Press the up or down arrows to change the displayed probe.







5. Press the set point button to save the new setting. Wait for the display to show the current temperature.

Maintenance & Servicing

Maintenance & Servicing

⚠ WARNING!	
	<ul style="list-style-type: none"> • Only qualified technicians should install and service the appliance. For assistance finding a qualified technician, please visit our Service Company Locator at truemfg.com/support/service-locator. • Turn off and lockout all utilities (gas, electric, water) according to approved practices during maintenance or servicing.
  	<p>The appliance owner is responsible for performing a Personal Protective Equipment (PPE) Hazard Assessment and ensuring adequate protection during maintenance and cleaning procedures.</p> <p>Use appropriate tools, safety equipment, and PPE during installation and servicing.</p>
	<p>Sharp Edges!</p> <ul style="list-style-type: none"> • Take care when moving, installing, cleaning, servicing, and maintaining the ice machine to avoid cuts. Be sure to take care when reaching under the ice machine or handling metal components. • Stay clear of pinch point areas, such as the space between appliance doors and surrounding cabinetry. Take care closing doors with children nearby.

⚠ WARNING!	
	<p>Risk of electric shock or burn!</p> <ul style="list-style-type: none"> • Powering off an electronic control or setting temperature controls to the 0 (off) position DOES NOT remove power from all components. Unplug the appliance or turn off the power supply before installation or servicing. • DO NOT clean appliance with a pressure washer or hose.
	<p>Flammable refrigerant/insulation used! Have a licensed service provider service your unit to minimize the risk of possible ignition due to incorrect parts or improper service and to ensure the operator's health and safety.</p>
	<p>Crush or cut hazard! Keep clear when uncrating, installing, moving, or servicing the appliance.</p>
	<p>Slippery Surfaces! Moisture from improper drainage can create slippery surfaces near the appliance. It is your duty to immediately warn your customers of, and dry, the slippery surface. All wet floor areas must be marked with a wet floor sign.</p>

Maintenance & Servicing (cont.)

ⓘ USER ACTION!



- For additional maintenance instruction, please visit the media center at truemfg.com.
- Any appliance adjustments are to be made **AFTER** the appliance has been verified level and properly supported.

ⓘ NOTICE!



The appliance owner is responsible for maintaining the appliance as described in the installation manual. Routine care and maintenance procedures are not covered by TRUE's warranty.

Component Replacement

- Replace components with original equipment manufacturer (OEM) components such as those shown in fig. 1. OEM parts minimize the risk of possible ignition due to incorrect parts. Use of non-OEM components may void TRUE's warranty.
- Have a licensed service provider service your unit to minimize the risk of possible ignition due to incorrect parts or improper service and to ensure the operator's health and safety.



Fig. 1. Example of OEM parts.

Maintenance & Servicing (cont.)

Recommended Maintenance

See recommended maintenance tasks and frequencies below. Some tasks may be required more frequently based on your installation.

Maintenance Tasks	Monthly	Quarterly	Annually
Verify the appliance maintains product temperature.	X	X	X
Inspect power cord for damage; if damaged, replace immediately.	X	X	X
Verify the power cord is fully plugged into the wall receptacle			X
Inspect the overall condition of the appliance and its components (such as castors, doors, and hinges).	X	X	X
Verify operation of all moving parts (such as fan motors, doors and door cords).			X
Check physical condition of all gaskets; verify gaskets seal correctly.		X	X
Inspect any lamps, lamp holder connections, LED modules, and LED module connections.	X	X	X
Check all condenser coils (fronts and backs) for dust and debris; if present, clear the debris.	X	X	X
Check physical condition of all condenser coils and evaporator coils; straighten coil fins as needed.		X	X
Check all evaporator coils for dust and debris; if present, clear the debris.		X	X
Verify the drain line is clear of debris.		X	X

Maintenance & Servicing (cont.)







Model: _____

Serial Number: _____

Jan.	Feb.	Mar.	Apr.	May	Jun.	Jul.	Aug.	Sep.	Oct.	Nov.	Dec.

Maintenance & Servicing (cont.)

Condenser Coil Cleaning

⚠ WARNING!	
  	<p>The appliance owner is responsible for performing a Personal Protective Equipment (PPE) Hazard Assessment and ensuring adequate protection during maintenance and cleaning procedures.</p> <p>Use appropriate tools, safety equipment, and PPE during installation and servicing.</p>
	<p>Risk of electric shock or burn!</p> <ul style="list-style-type: none"> • Unplug the appliance or turn off the power supply before installation or servicing. • DO NOT clean appliance with a pressure washer or hose.
	<p>Sharp edges! Coil fins are sharp and metal components can have sharp edges. Take care when moving, installing, cleaning, servicing, and maintaining the appliance to avoid cuts.</p>
	<p>Risk of eye injury! Airborne dust and debris can cause eye injury. Eye protection recommended.</p>

ⓘ NOTICE!	
	<p>The cleaning of the condenser coil is not covered by warranty!</p>

Required Tools

Required tools include (but may nit be limited to) the following:

- Ladder [> 6' (1.8m)]
- Eye protection
- Gloves
- Phillips Screwdriver or Bit Driver
- Stiff Bristle Brush
- Flashlight
- Tank of Compressed Air
- Vaccum Cleaner
- Drill (optional)

Maintenance & Servicing (cont.)

Condenser Coil Cleaning (cont.)

Procedure

1. Unplug the unit or turn off the power supply.
2. Remove the front shroud(s). See fig. 1.

NOTICE > On FOUR SECTION UNITS, the front shrouds are connected. See fig. 2.
3. With a stiff bristle brush, carefully clean accumulated dirt from the front condenser coil fins See fig. 3.
4. With dirt removed from the surface of the coil, use a flashlight to verify that you can see through the coil and observe the condenser fan blade spinning. See fig. 4.
5. If the view is clear, vacuum any dirt around the condensing unit area, reinstall the front shroud(s), and then restore power and verify operation.
6. If the view is still blocked with dirt, proceed to the next step.
7. Gently blow compressed air or CO₂ through the coil until it is clean.
8. Carefully vacuum any dirt around the condensing unit area.
9. Reinstall the front shroud(s), restore power to the unit, and verify operation.

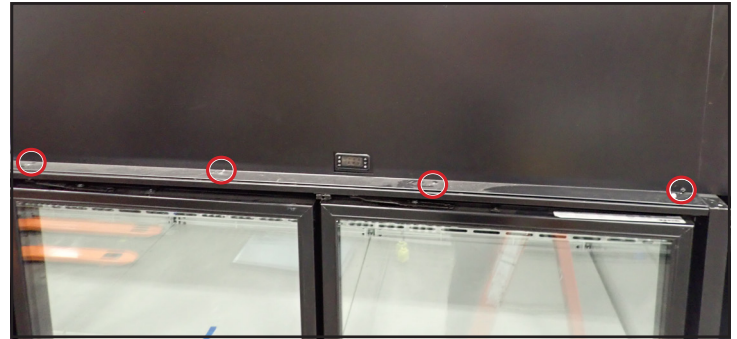

Fig. 1. Front shroud screw locations.

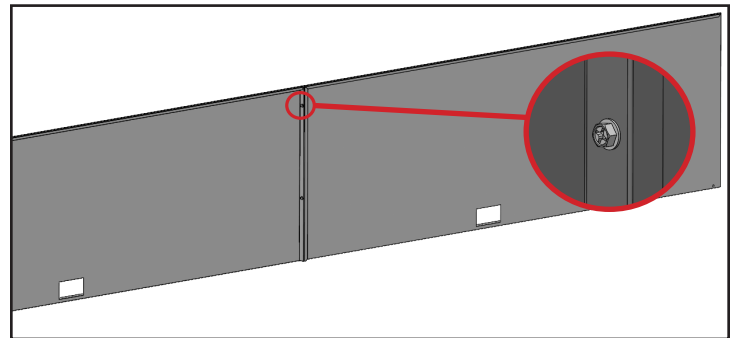

Fig. 2. Connected front shrouds.

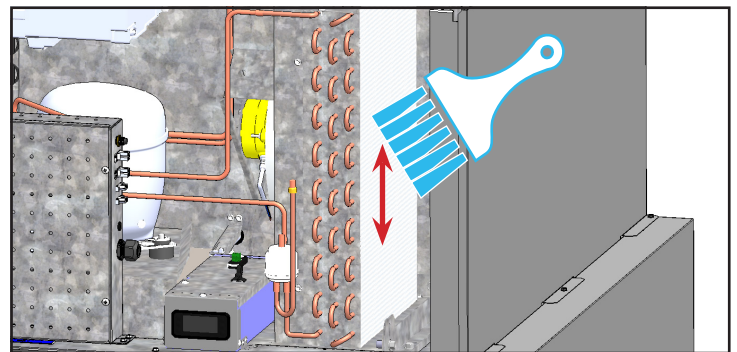

Fig. 3. Never brush across coil fins.

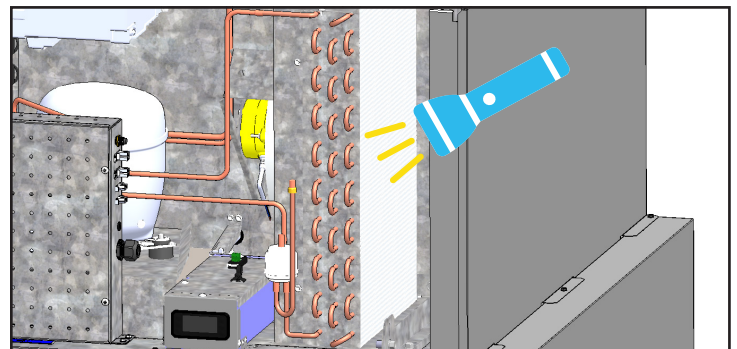

Fig. 4. Verify all blockages have been removed.







Additional Information

If you have any questions, please contact your local TRUE Manufacturing Service Department. See the front cover for locations and contact information.

- **DO NOT** place any filter material in front of the condensing coil.

Maintenance & Servicing (cont.)

General Surface Care & Cleaning

⚠ WARNING!	
 	<p>Risk of electrical shock or fire!</p> <p>DO NOT clean appliance with a pressure washer or hose.</p>
	<p>Slippery Surfaces! Moisture from improper drainage can create slippery surfaces near the appliance. It is your duty to immediately warn your customers of, and dry, the slippery surface. All wet floor areas must be marked with a wet floor sign.</p>
  	<p>The appliance owner is responsible for performing a Personal Protective Equipment (PPE) Hazard Assessment and to ensure adequate protection during maintenance and cleaning procedures.</p> <p>Use appropriate tools, safety equipment, and PPE during installation and servicing.</p>

Gaskets

- Clean gaskets with warm soapy water.
- **DO NOT** use sharp tools or knives to scrape a gasket.
- Avoid full-strength cleaning products.

Interior

- Clean interior surfaces with a mild solution of baking soda and water to help reduce odor; **DO NOT** use harsh or abrasive cleaners.
- For plastic or powder-coated parts, use warm soapy water to clean **DO NOT** use stainless steel cleaners or similar solvents.

Exterior

- For plastic or powder-coated parts, use warm soapy water to clean **DO NOT** use stainless steel cleaners or similar solvents.
- **DO NOT** clean stainless steel with steel wool or abrasive products. **DO NOT** use detergents or degreasers with chlorides or phosphates.

Maintenance & Servicing (cont.)

Stainless Steel Care & Cleaning

! USER ACTION	
!	DO NOT use any steel wool, abrasive, or chlorine-based products to clean stainless steel surfaces.

Stainless Steel Opponents

There are three basic things which can break down your stainless steel's passivity layer and allow corrosion to form.

- Scratches from wire brushes, scrapers, steel pads, and other items that can be abrasive to stainless steel's surface.
- Deposits left on your stainless steel can leave spots. You may have hard or soft water depending on what part of the country you live in. Hard water can leave spots. Hard water that is heated can leave deposits if left to sit too long. These deposits can cause the passive layer to break down and rust your stainless steel. All deposits left from food prep or service should be removed as soon as possible.
- Chlorides which are present in table salt, food and water, as well as in household and industrial cleaners. These are the worst type of chlorides to use on stainless steel.

Stainless Steel Cleaning and Restoration

Stainless steel cleaners must be free of phosphates, chlorine, chloride, and ammonia.

True offers environmentally-friendly cleaner and polish through our True Store at store.trueresidential.com/products/stainless-steel-clean-polish-kit.

Custom Painted Appliance and Hardware

For painted doors and other surfaces, use a mild solution of soap and water with a soft microfiber cloth.

Maintenance & Servicing (cont.)

8 Tips to Help Prevent Rust on Stainless Steel

Maintain the Cleanliness of Your Equipment

Avoid build-up of hard stains by cleaning frequently. Use cleaners at the recommended strength (alkaline chlorinated or non-chloride).

Use the Correct Cleaning Tools

Use non-abrasive tools when cleaning your stainless steel products. The stainless steel's passive layer will not be harmed by soft cloths and plastic scouring pads.

Clean Along Polishing Lines

Polishing lines ("grain") are visible on some stainless steels. Always scrub parallel to polishing lines when visible. Use a plastic scouring pad or soft cloth when you cannot see the grain.

Use Alkaline, Alkaline-Chlorinated or Non-Chloride Cleaners

While many traditional cleaners are loaded with chlorides, the industry is providing an ever increasing choice of non-chloride cleaners. If you are not sure of your cleaner's chloride content, contact your cleaner supplier. If they tell you that your present cleaner contains chlorides, ask if they have an alternative. Avoid cleaners containing quaternary salts, as they can attack stainless steel, causing pitting and rusting.

Rinse

When using chlorinated cleaners, you must rinse and wipe dry immediately. It is better to wipe standing cleaning agents and water as soon as possible. Allow the stainless steel equipment to air dry. Oxygen helps maintain the passivity film on stainless steel.

Never Use Hydrochloric Acid (Muriatic Acid) on Stainless Steel

Even diluted, hydrochloric acid can cause corrosion, pitting and stress corrosion cracking of stainless steel.

Water Treatment

To reduce deposits, soften hard water when possible. Installation of certain filters can remove corrosive and distasteful elements. Salts in a properly maintained water softener can also be to your advantage. Contact a treatment specialist if you are not sure of the proper water treatment.

Regularly Restore & Passivate Stainless Steel

Stainless steel gets its stainless properties from the protective chromium oxides on its surface. If these oxides are removed by scouring, or by reaction with harmful chemicals, then the iron in the steel is exposed and can begin to oxidize, or rust. Passivation is a chemical process that removes free iron and other contaminants from the surface of stainless steel, allowing the protective chromium oxides to re-form.

Maintenance and Servicing (cont.)

Door Adjustments & Reversal

Verify door alignment and operation before adjusting the alignment or tension.

Alignment Adjustment

! NOTICE!

!

Before adjusting doors down, be sure to remove the door shipping plate! Reinstall the door shipping plate screws. See figs. 1 and 2.

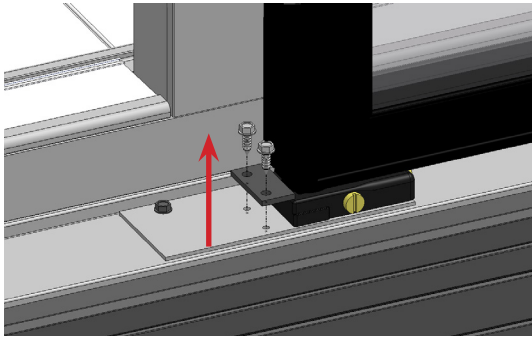

Fig. 1. Remove the door shipping plate.

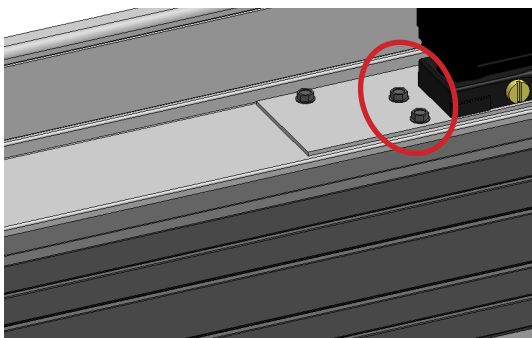

Fig. 2. Reinstall the door shipping plate screws.

Turn the door alignment adjustment screw to adjust the door alignment. See fig. 3.

- Clockwise turn: Adjust doors down
- Counterclockwise turn: Adjust doors up



Fig. 3. Door alignment adjustment screw location at the bottom of the door.

Tension Adjustment

Doors should be self-closing when opened 2-3" (50.8-76.2 mm).

Turn the door tension adjustment screw to adjust the door tension. See fig. 4.



- Clockwise turn: Decrease door tension
- Counterclockwise turn: Increase door tension



Fig. 4. Door tension adjustment screw location at the bottom of the door.

Maintenance & Servicing (cont.)

Removal

⚠ WARNING!	
	Assistance recommended! Door weight exceeds 50 lb (22.7 kg). Do not lift or support the door by the handle.
	Crush or cut hazard! Doors are heavy. Be prepared to support the door's weight during removal. Do not lift or support the door by the handle.

Required Tools

Required tools include (but may not be limited to) the following:

- Phillips Screwdriver or Bit Driver
- Needle Nose Pliers
- Drill (optional)

Procedure

1. Remove the door tension. See "Tension Adjustment" (pg. 33).
2. Disconnect the hold-open bracket from the appliance. See fig. 5.
3. Disconnect the top of the door from the appliance.

NOTICE > Be prepared to support the door's weight.

- a. Open the door approximately 70°.
 - b. With needle nose pliers, compress the hinge pin (see fig. 6).
 - c. While compressing the hinge pin, carefully pull the top of the door away from the appliance.
4. Lift the door (by the frame) from the bottom hinge. Carefully set the door aside.
 - Do not lift the door by the handle.
 - The torsion rod may remain in the torque master hole when lifting the door. If so, have an assistant lift the torsion rod out of the hole. See fig. 7.



Fig. 5. Shelf shipping bracket location. One bracket shown.

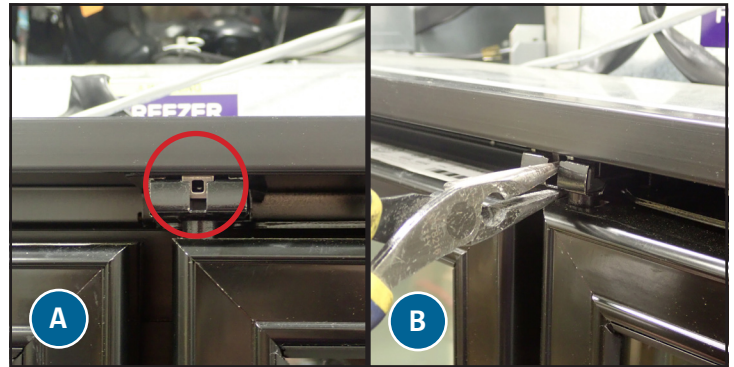



Fig. 6. Hinge pin at the top of the door (A). Compress the hinge pin (B).



Fig. 7. An assistant lifting the torsion rod from the torque master hole while the technician lifts the door.

Maintenance and Servicing (cont.)

Installation

⚠ WARNING!	
	Assistance recommended! Door weight exceeds 50 lb (22.7 kg). Do not lift or support the door by the handle.
	Crush or cut hazard! Doors are heavy. Be prepared to support the door's weight during removal. Do not lift or support the door by the handle.

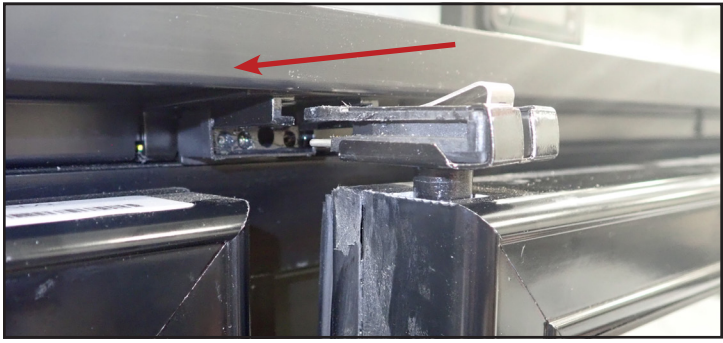

Fig. 8. Align the hinge pin.

Required Tools

Required tools include (but may not be limited to) the following:

- Phillips Screwdriver or Bit Driver
- Rubber Mallet (possible)
- Drill (optional)

Procedure

1. Lift the door (by the frame) and set it in the torque master hole. Be sure the door is fully seated.

NOTICE > Do not lift the door by the handle.

2. Hold the door perpendicular to the appliance.
3. Align the hinge pin (see fig. 8). Then, push the door's top towards the appliance until the hinge pin clicks into place.

NOTICE > Getting the hinge pin fully seated may require a rubber mallet.
4. Verify the hinge pin securely holds the door. Pull down on the door.
5. Install the hold-open bracket onto the appliance. See fig. 9.
6. Add door tension until the door gently self-closes from 2-3" (50.8-76.2 mm). See "Tension Adjustment" (pg. 33).
7. Verify door alignment. Adjust alignment as needed. See "Alignment Adjustment" (pg. 33).



Fig. 9. Hold open bracket screw location at the top of the door.

Maintenance & Servicing (cont.)

Reversal

⚠ WARNING!



Assistance recommended! Door weight exceeds 50 lb (22.7 kg). Do not lift or support the door by the handle.



Crush or cut hazard! Doors are heavy. Be prepared to support the door's weight during removal. Do not lift or support the door by the handle.

ⓘ NOTICE!



Only the rightmost doors on N sides can be reversed. See your full model name.

Only freezer doors contain wires.

Required Tools

Required tools include (but may not be limited to) the following:

- Phillips Screwdriver or Bit Driver
- Needle Nose Pliers
- 7/16" Socket wrench
- Putty Knife
- 1/4" Hex Head Driver
- Drill (optional)

Procedure

1. Locate the replacement torque master plate and cover plate in the interior packaging with the leveling tools. See fig. 10. Set aside.
2. Remove the door. See "Removal" (pg. 34).
3. Carefully lay the removed door handle-side down.
4. Reverse the door.
 - a. Remove the wire cover from the door's side. See fig. 11.
 - b. If applicable, disconnect the hinge pin wires. See figs. 12 and 13.
 - c. Remove the hinge pin.
 - d. Carefully remove the torsion rod.

NOTICE > Removing the torsion rod may require slightly rotating the rod to get the torsion rod cap to clear the door. See fig. 14.

- e. Install the torsion rod in the opposite side
- f. Install the hinge pin in the opposite side. If applicable, connect the hinge pin wires as follows:

- **Hinge pin white** to **door white**
- **Hinge pin red** to **door black**
- **Ground** to **door**

g. Reinstall the wire cover.

h. Remove the hold-open bracket.

i. Remove the plastic cap. See fig. 15

j. Swap the hold-open bracket and plastic cap locations.

NOTICE > Hold-open bracket installs with the convex side facing the door.

k. Move the magnet assembly to the opposite side.

NOTICE > Magnet assembly holes are predrilled.

5. If applicable, move the hinge pin plug to the opposite side. See fig. 16.
6. If applicable, move the hinge pin cover to the opposite side. See fig. 17.
7. Remove the torque master assembly and the existing cover. See fig. 18.
8. Move the torque master to the replacement torque master plate. See fig. 19.
9. Install the replacement cover and replacement torque master assembly on the opposite sides.

NOTICE > Be sure to install the replacement torque master assembly with the alignment adjustment screw out. See fig. 20.
10. Install the reversed door. See "Installation" (pg. 35).

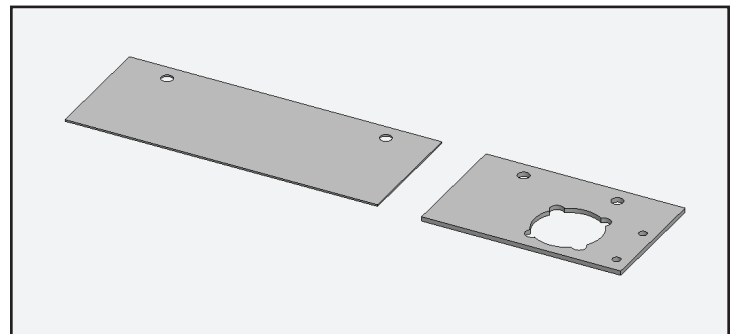

Fig. 10. Cover plate and torque master plate. Located in the interior packaging with the leveling tools.

Maintenance and Servicing (cont.)

Reversal (cont.)



Fig. 11. Wire cover located in the hinge-side of the door in the center.

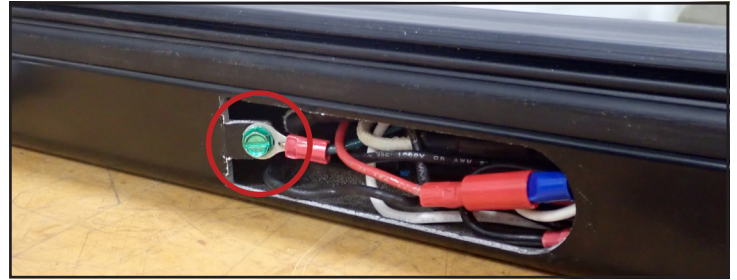

Fig. 12. Hinge pin ground screw location.

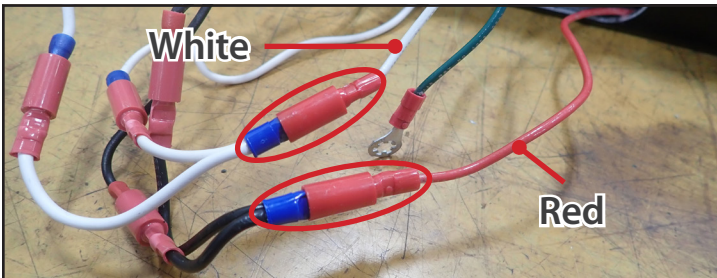

Fig. 13. Hinge pin wire connectors.



Fig. 14. Torsion rod cap.



Fig. 15. Plastic cap in the door's bottom.

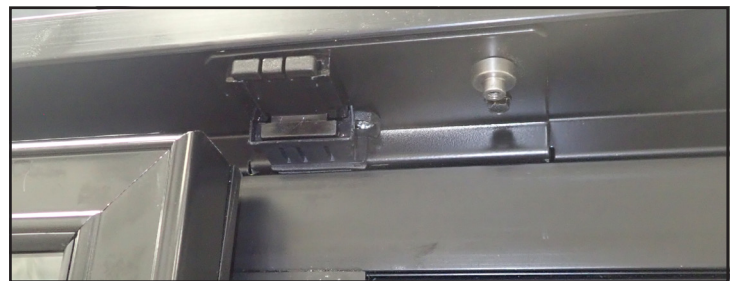

Fig. 16. Hinge pin plug installed on opposite side.

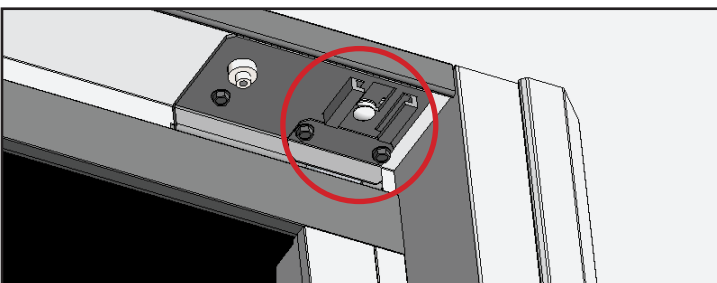

Fig. 17. Hinge pin cover located on appliance upper right.



Fig. 18. Original torque master assembly and cover locations.



Fig. 19. Move the torque master to the replacement plate. Rotate counterclockwise to lock; clockwise to unlock. Rotate counterclockwise to lock; clockwise to unlock.

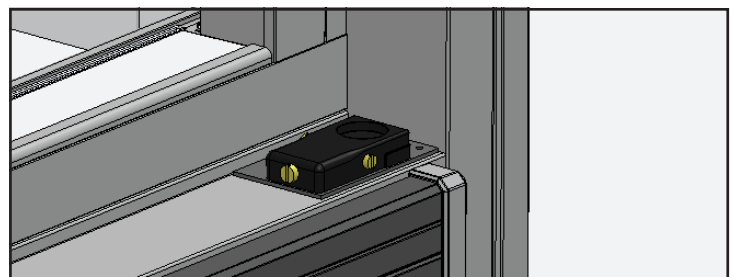











Fig. 20. Correctly installed replacement torque master assembly.

Optional Accessories (not included)

Optional Accessories (not included)

⚠ WARNING!	
	<ul style="list-style-type: none"> • Only qualified technicians should install and service the appliance. For assistance finding a qualified technician, please visit our Service Company Locator at truemfg.com/support/service-locator. • Turn off and lockout all utilities (gas, electric, water) according to approved practices during maintenance or servicing.
  	<p>The appliance owner is responsible for performing a Personal Protective Equipment (PPE) Hazard Assessment and ensuring adequate protection during maintenance and cleaning procedures.</p> <p>Use appropriate tools, safety equipment, and PPE during installation and servicing.</p>
	<p>Sharp Edges!</p> <ul style="list-style-type: none"> • Take care when moving, installing, cleaning, servicing, and maintaining the ice machine to avoid cuts. Be sure to take care when reaching under the ice machine or handling metal components. • Stay clear of pinch point areas, such as the space between appliance doors and surrounding cabinetry. Take care closing doors with children nearby.
	<p>Crush or cut hazard! Keep clear when uncrating, installing, moving, or servicing the appliance.</p>

⚠ WARNING!	
	<p>Sharp Edges!</p> <ul style="list-style-type: none"> • Take care when moving, installing, cleaning, servicing, and maintaining the ice machine to avoid cuts. Be sure to take care when reaching under the ice machine or handling metal components. • Stay clear of pinch point areas, such as the space between appliance doors and surrounding cabinetry. Take care closing doors with children nearby.
	<p>Crush or cut hazard! Keep clear when uncrating, installing, moving, or servicing the appliance.</p>
	<p>Risk of electrical shock or fire!</p> <p>Powering off an electronic control does not remove power from all components. Unplug the appliance or turn off the power supply before installation or servicing.</p>

Optional Accessories (not included) (cont.)

Heated Drain Pan (HDP)

True offers a heated drain (HDP) pan to help ensure the condensate drain pan does not overflow in high usage and/or high ambient conditions. The HDP is an option only if required for the application.

Procedure

1. Unplug the unit or turn off the power supply.
2. Plug the HDP into the refrigeration deck electrical box. See fig. 1.
3. Position the HDP underneath the condensate drain pan overflow nozzle. See fig. 2.
4. Fold the HDP tabs over the condensate drain pan. See fig. 3.
5. Secure the HDP power cord away from hot or moving parts.

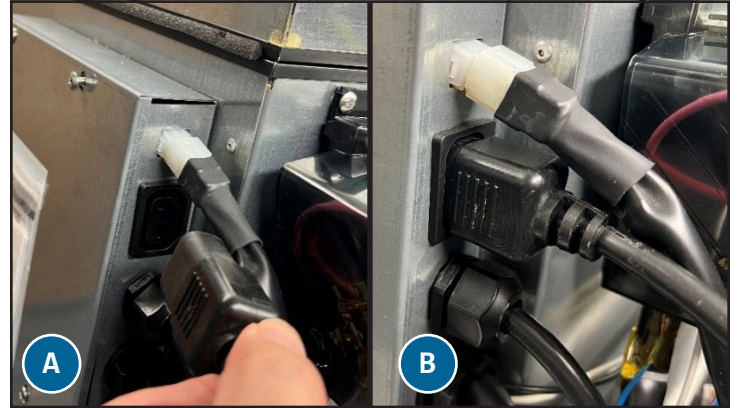

Fig. 1. Plug the HDP into the refrigeration deck electrical box.



Fig. 2. Position the HDP under the overflow nozzle.



Fig. 3. Fold the HDP tabs over to hook the HDP to the condensate drain pan.

Warranty Information (USA & Canada Only)

THREE-YEAR PARTS & LABOR WARRANTY

TRUE warrants to the original purchaser of every new TRUE refrigerated unit, the cabinet, and all parts thereof, to be free from defects in material or workmanship, under normal and proper use and maintenance service as specified by TRUE and upon proper installation and start-up in accordance with the instruction packet supplied with each TRUE unit. TRUE's obligation under this warranty is limited to a period of three (3) years from the date of the original installation. Any warranty coverage is dependent on the purchase date of the cabinet being within 39 months of the original ship date from TRUE.

Any part covered under this warranty that is determined by TRUE to have been defective within this time frame, is limited to the repair or replacement, including labor charges, of defective parts or assemblies. The labor warranty shall include standard straight time labor charges only and reasonable travel time, as determined by TRUE.

Warranty does not cover standard wear parts which include door gaskets. Warranty also does not cover issues caused by improper installation or lack of basic preventative maintenance.

HYDROCARBON COMPRESSOR DECK WARRANTY

Compressors determined by TRUE to have been defective within the THREE (3) year time period will, at TRUE's option, be either repaired or replaced with a compressor or compressor parts of similar design and capacity.

The compressor warranty will be voided if the following procedure is not carefully adhered to:

1. This system contains R290 refrigerant and polyol ester lubricant. The polyol ester lubricant has rapid moisture absorbing qualities. If long exposure to the ambient conditions occur, the lubricant must be removed and replaced with new. For oil amounts and specifications please call TRUE technical service department (855-372-1368). Failure to comply with recommended lubricant specification will void the compressor warranty.
2. Drier replacement is very important and must be changed when a system is opened for servicing. An OEM exact replacement should be used. The new drier must also be the same capacity as the drier being replaced.
3. Micron level vacuums must be achieved to ensure low moisture levels in the system. 500 microns or lower must be obtained.
4. All True Good Refrigeration Practices must be followed. Visit www.TrueMfg.com to view Good Refrigeration Practices under the Warranty Claim Form.

WARRANTY CLAIMS

All claims for labor or parts must be made directly through TRUE. All claims should include: model number of the unit, the serial number of the unit and refrigeration deck, proof of purchase, date of installation, and all pertinent information supporting the existence of the alleged defect.

In case of warranty compressor, a picture of the compressor model tag must be returned to TRUE along with above listed information. For warranty claim information, visit www.truemfg.com/Support/Warranty-Support. Failure to notify TRUE within three (3) months of the defect giving rise to the breach will bar any remedy under warranty. True reserves the right to request any failed part covered under warranty to be returned.

WHAT IS NOT COVERED BY THIS WARRANTY

TRUE's sole obligation under this warranty is limited to either repair or replacement of parts, at TRUE's option and subject to the additional limitations below. This warranty neither assumes nor authorizes any person to assume obligations other than those expressly covered by this warranty.

NO CONSEQUENTIAL DAMAGES. True is not responsible for economic loss; profit loss; or special, indirect or consequential damages, including without limitation, loss or damage arising from loss of product, whether or not on account of failure of refrigeration.

WARRANTY IS NOT TRANSFERABLE. This warranty is not assignable and applies only in favor of the original purchaser/user to whom delivered. ANY SUCH ASSIGNMENT OR TRANSFER SHALL VOID THE WARRANTIES HEREIN MADE AND SHALL VOID ALL WARRANTIES, EXPRESS OR IMPLIED.

IMPROPER USAGE/INSTALLATION/MAINTENANCE. TRUE assumes no liability for parts or labor coverage for component failure or other damages resulting from improper usage or installation or failure to clean and/or maintain product as set forth in the installation manual provided with the unit.

RELOCATION FOR REPAIR. True is not responsible for the cost to move the TRUE unit or any other fixture or piece of equipment for any reason from its position of operation on the user's premises to make a warranty repair.

NON-OEM PARTS. OEM parts will be provided under this warranty free of charge to the end-user. True is not responsible for defects or damage caused by parts not approved by TRUE. Warranty will be voided for any damage caused by a non-OEM part.

ALTERATION, NEGLIGENCE, ABUSE, MISUSE, ACCIDENT, DAMAGE DURING TRANSIT OR INSTALLATION, FIRE, FLOOD, ACTS OF GOD. TRUE is not responsible for the repair or replacement of any parts that TRUE determines have been subjected after the date of manufacture to alteration, neglect, abuse, misuse, accident, or damage during transit or installation, fire, flood, or act of God.

IMPROPER ELECTRICAL CONNECTIONS. TRUE is not responsible for the repair or replacement of failed or damaged components resulting from incorrect supply voltage, the use of extension cords, low voltage, or unstable supply voltage.

NO IMPLIED WARRANTY OF MERCHANTABILITY OR FITNESS FOR A PARTICULAR PURPOSE: THERE ARE NO OTHER WARRANTIES, EXPRESSED, IMPLIED OR STATUTORY, EXCEPT AS SET FORTH IN THIS WARRANTY STATEMENT. THESE WARRANTIES ARE EXCLUSIVE AND IN LIEU OF ALL OTHER WARRANTIES, EXPRESS OR IMPLIED, INCLUDING IMPLIED WARRANTY AND MERCHANTABILITY OR FITNESS FOR A PARTICULAR PURPOSE. THERE ARE NO WARRANTIES WHICH EXTEND BEYOND THE DESCRIPTION ON THE FACE HEREOF.

OUTSIDE THE US & CANADA: This warranty does not apply to, and TRUE is not responsible for, any warranty claims made on products sold or used outside of the US and Canada

ENVIRONMENTAL ATTRIBUTES

Any and all environmental attributes, including environmental offset credit rights, with respect to TRUE® refrigeration units manufactured after September 1, 2015, shall remain the property of True Manufacturing Co., Inc. and are not transferred.

This warranty only applies to units shipped from True's manufacturing facilities after January 1, 2023 for US and Canada.

NOTES

Lined writing area with multiple horizontal lines.



www.truemfg.com